

PEUGEOT

# RIFTER 2019>

KOD / CODE : 5732MSY111

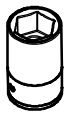

SW13 (20Nm)

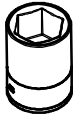

SW17 (40Nm)

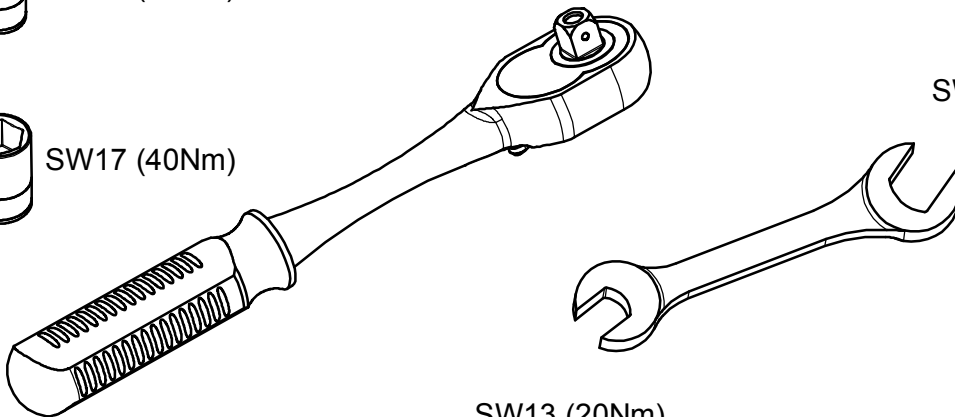

SW17 (40Nm)

SW13 (20Nm)

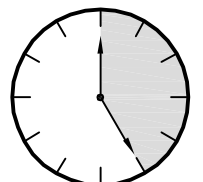

25 DAKİKA

# MONTAJ SETİ / INSTALLATION SET

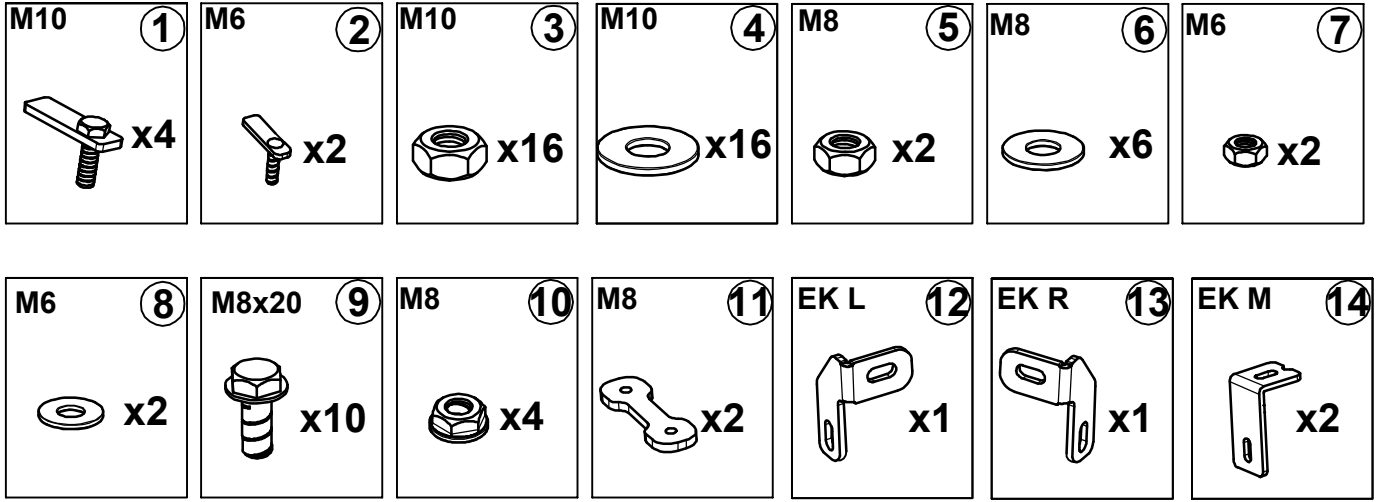

1. M10 LAMALI CİVATA / M10 MOUNTING PLATE
2. M6 LAMALI CİVATA / M6 MOUNTING PLATE
3. M10 SOMUN / M10 NUT
4. M10 PUL / M10 WASHER
5. M8 SOMUN / M10 NUT
6. M8 PUL / M10 WASHER
7. M6 SOMUN / M10 NUT
8. M6 PUL / M10 WASHER
9. M8x20 FLANŞLI CİVATA / M8x20 FLANGED BOLT
10. M8 FLANŞLI SOMUN / M8 NUT
11. M8 ÖZEL SOMUN / M8 SPECIAL NUT
12. EK PARÇA SOL / ADDITIONAL LEFT
13. EK PARÇA SAĞ / ADDITIONAL RIGHT
14. EK PARÇA / ADDITIONAL PART

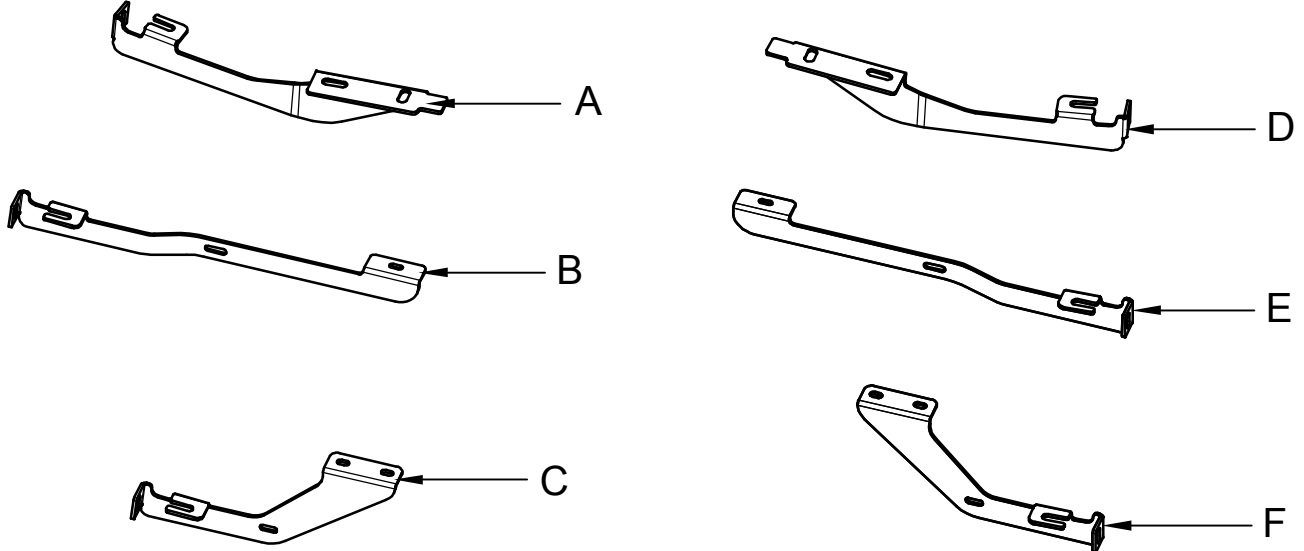

## **BRAKETLER / BRACKETS**

- A. 5732MSY R F / SAĞ ÖN BRAKET / RIGHT FRONT BRACKET
- B. 5732MSY R M / SAĞ ORTA BRAKET / RIGHT MIDDLE BRACKET
- C. 5732MSY R R / SAĞ ARKA BRAKET / RIGHT REAR BRACKET
- D. 5732MSY L F / SOL ÖN BRAKET / LEFT FRONT BRACKET
- E. 5732MSY L M / SOL ORTA BRAKET / LEFT MIDDLE BRACKET
- F. 5732MSY L R / SOL ARKA BRAKET / LEFT REAR BRACKET

Fig. 1



ARAÇ ÜZERİNDEKİ PLASTİK TAPALARI SÖKÜNÜZ

PLEASE REMOVE THE STOPPER THAT ALREADY ATTACHED ON THE VEHICLE



LF

Fig. 5



ARAÇ ÜZERİNDEKİ TAPAYI SÖKÜNÜZ

PLEASE REMOVE THE STOPPER THAT ALREADY ATTACHED ON THE VEHICLE



LR

Fig. 2

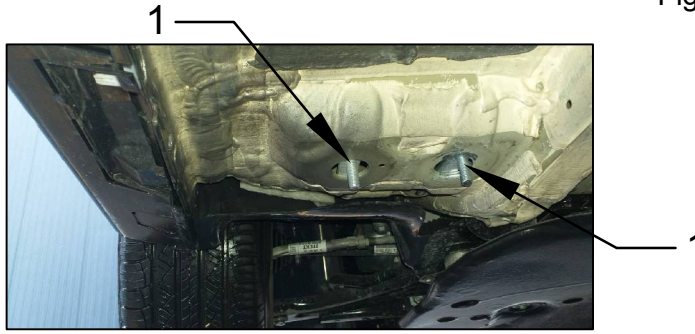

1 NUMARALI PARÇAYI YERİNE TAKINIZ

PLEASE ATTACH THE PART (PART NO 1) TO THE PLACE SHOWN ABOVE



LF

Fig. 6

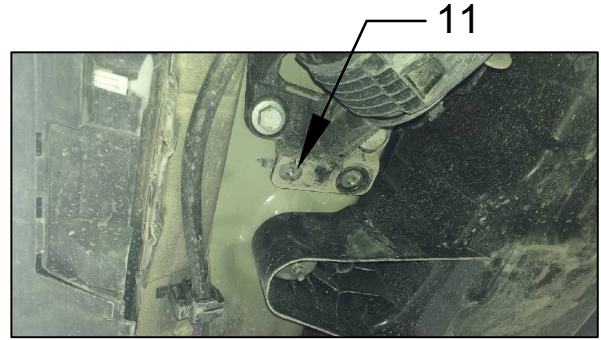

9 NUMARALI PARÇAYI YERİNE TAKINIZ

PLEASE ATTACH THE PART (PART NO 9) TO THE PLACE SHOWN ABOVE



LR

Fig. 3



BRAKETİ CİVATALAR İLE MONTAJLAYINIZ

INSTALL THE BRACKET WITH BOLTS



LF

Fig. 7

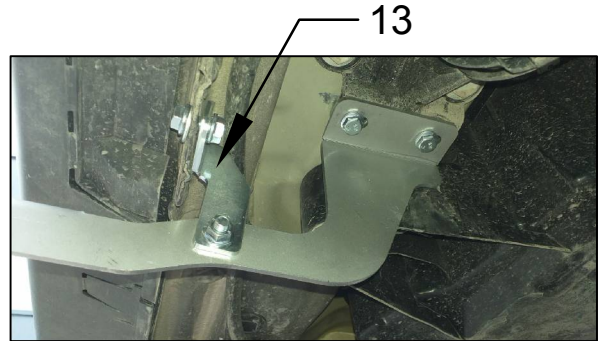

13 NUMARALI PARÇAYI YERİNE TAKINIZ

PLEASE ATTACH THE PART (PART NO 13) TO THE PLACE SHOWN ABOVE

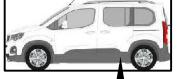

LR

Fig. 4



BRAKETİ CİVATALAR İLE MONTAJLAYINIZ

INSTALL THE BRACKET WITH BOLTS



LF

Fig. 8



BRAKETİ CİVATALAR İLE MONTAJLAYINIZ

INSTALL THE BRACKET WITH BOLTS



ARAÇ ÜZERİNDEKİ PLASTİK KAPAĞI SÖKÜNÜZ

PLEASE REMOVE THE STOPPER THAT  
ALREADY ATTACHED ON THE VEHICLE



LM

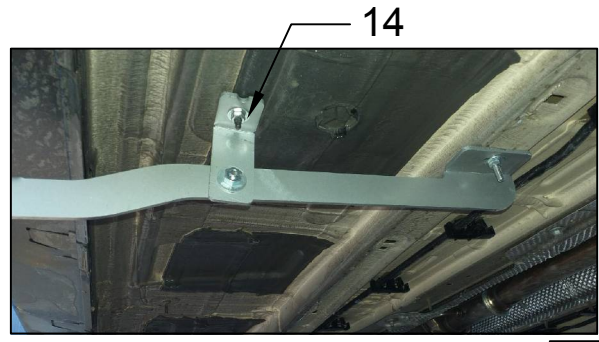

BRAKETİ CİVATALAR İLE MONTAJLAYINIZ

INSTALL THE BRACKET WITH BOLTS



LM

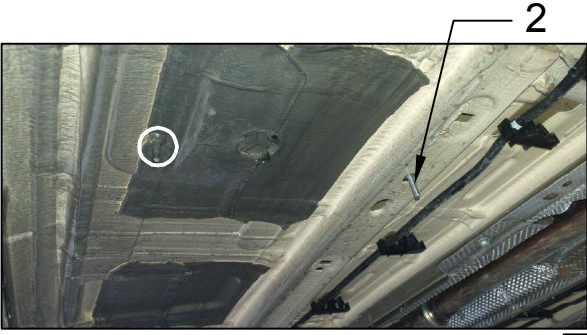

2 NUMARALI PARÇAYI YERİNE TAKINIZ

PLEASE ATTACH THE PART (PART NO 2)  
TO THE PLACE SHOWN ABOVE



LM

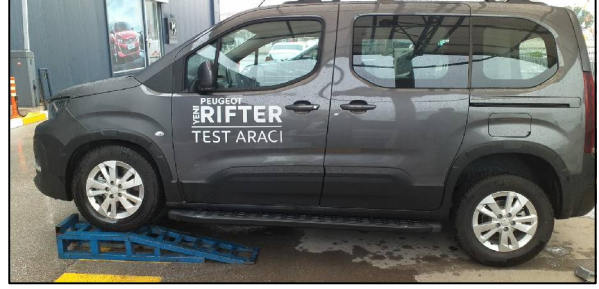

ÜRÜNÜ MONTAJLAYINIZ

PLEASE INSTALL THE PRODUCT

## MONTAJ ŞEMASI / INSTALLATION SCHEME

