

FIORINO 2008> BIPPER 2008> NEMO 2008>

KOD / CODE : 2521DLY101

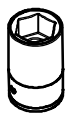

SW13 (20Nm)



SW17 (40Nm)

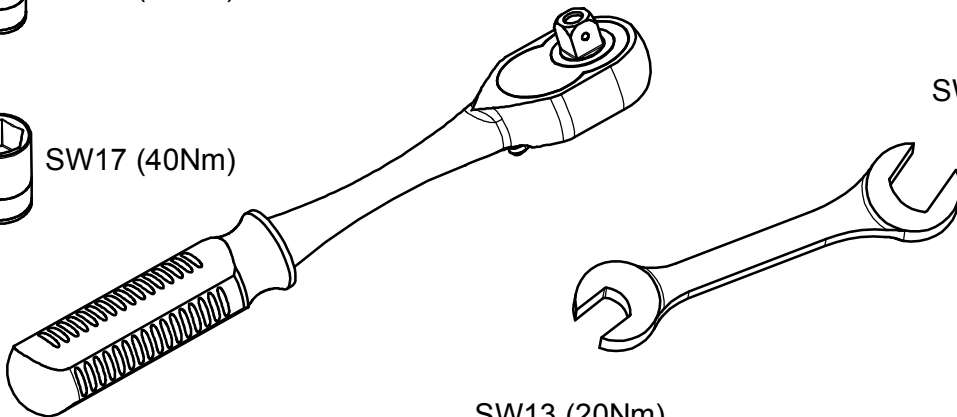

SW17 (40Nm)

SW13 (20Nm)

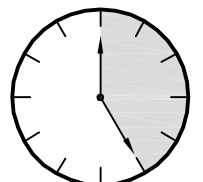

25 DAKİKA

MONTAJ SETİ / INSTALLATION SET

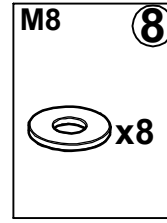
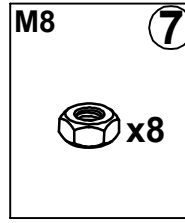
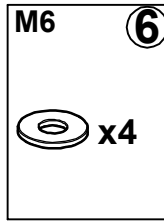
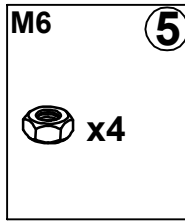
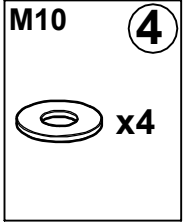
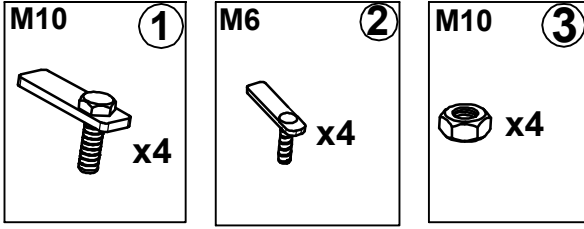

1. M10 LAMALI CİVATA / M10 MOUNTING PLATE
2. M6 LAMALI CİVATA / M6 MOUNTING PLATE
3. M10 SOMUN / M10 NUT
4. M10 PUL / M10 WASHER
5. M6 SOMUN / M6 NUT
6. M6 PUL / M6 WASHER
7. M8 SOMUN / M8 NUT
8. M8 PUL / M8 WASHER

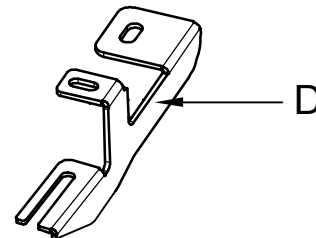
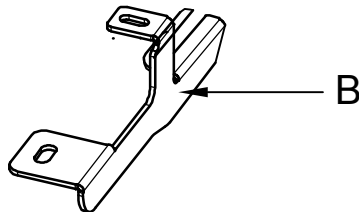
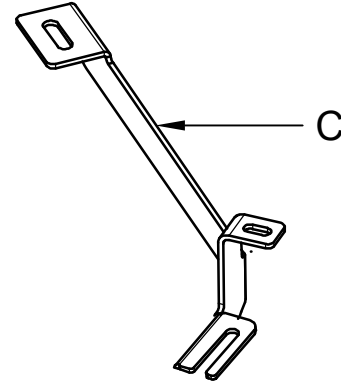
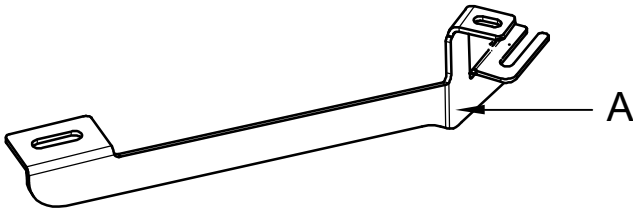

BRAKETLER / BRACKETS

- A. 2521DLY R F / SAĞ ÖN BRAKET / RIGHT FRONT BRACKET
B. 2521DLY R R / SAĞ ARKA BRAKET / RIGHT REAR BRACKET
C. 2521DLY L F / SOL ÖN BRAKET / LEFT FRONT BRACKET
D. 2521DLY L R / SOL ARKA BRAKET / LEFT REAR BRACKET



1

1



LF

1 NUMARALI PARÇAYI YERİNE TAKINIZ
PLEASE ATTACH THE PART (PART NO 1)
TO THE PLACE SHOWN ABOVE



5



LR



ARAÇ ÜZERİNDEKİ PLASTİK KAPAĞI SÖKÜNÜZ
PLEASE REMOVE THE STOPPER THAT
ALREADY ATTACHED ON THE VEHICLE



2



LF

ARAÇ ÜZERİNDEKİ PLASTİK KAPAĞI SÖKÜNÜZ
PLEASE REMOVE THE STOPPER THAT
ALREADY ATTACHED ON THE VEHICLE



6

1



LR

1 NUMARALI PARÇAYI YERİNE TAKINIZ
PLEASE ATTACH THE PART (PART NO 1)
TO THE PLACE SHOWN ABOVE

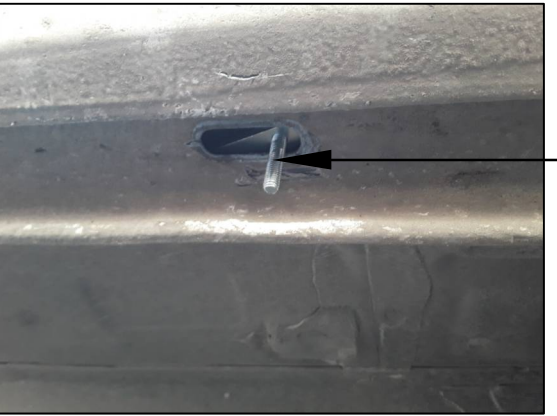

3

2



LF

2 NUMARALI PARÇAYI YERİNE TAKINIZ
PLEASE ATTACH THE PART (PART NO 2)
TO THE PLACE SHOWN ABOVE



7

2



LR

2 NUMARALI PARÇAYI YERİNE TAKINIZ
PLEASE ATTACH THE PART (PART NO 2)
TO THE PLACE SHOWN ABOVE



4



LF

BRAKETİ CİVATALAR İLE MONTAJLAYINIZ
INSTALL THE BRACKET WITH BOLTS



8



LR

BRAKETİ CİVATALAR İLE MONTAJLAYINIZ
INSTALL THE BRACKET WITH BOLTS



ÜRÜNÜ MONTAJLAYINIZ
PLEASE INSTALL THE PRODUCT



ÜRÜNÜ MONTAJLAYINIZ
PLEASE INSTALL THE PRODUCT

MONTAJ ŞEMASI / INSTALLATION SCHEME

