

VOKSWAGEN AMAROK 2010>

KOD / CODE : 7535ABA176

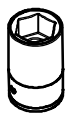

SW10 (20Nm)

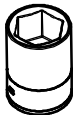

SW17 (40Nm)

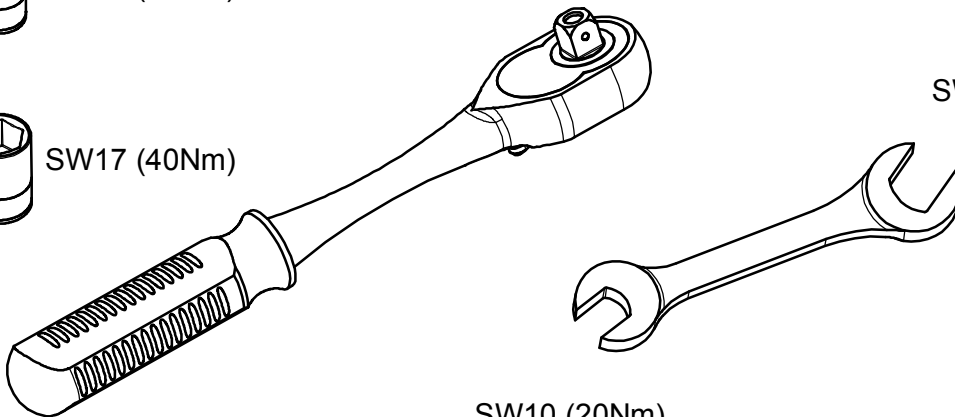

SW17 (40Nm)

SW10 (20Nm)

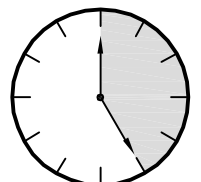

25 DAKİKA

MONTAJ SETİ / INSTALLATION SET

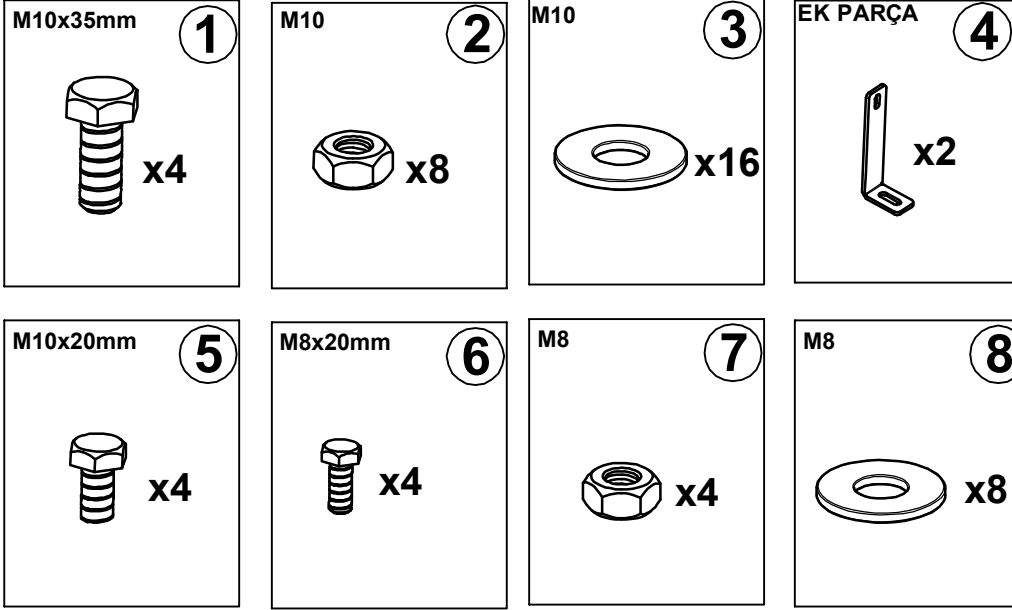

1. M10x35 ANAHTAR BAŞLI CİVATA / M10x35 KEY HEAD BOLT
2. M10 SOMUN / M10 NUT
3. M10 PUL / M10 WASHER
4. M10x20 ANAHTAR BAŞLI CİVATA / M10x20 KEY HEAD BOLT
5. M8x20 ANAHTAR BAŞLI CİVATA / M8x20 KEY HEAD BOLT
6. M6 SOMUN / M6 NUT
7. M6 PUL / M6 WASHER

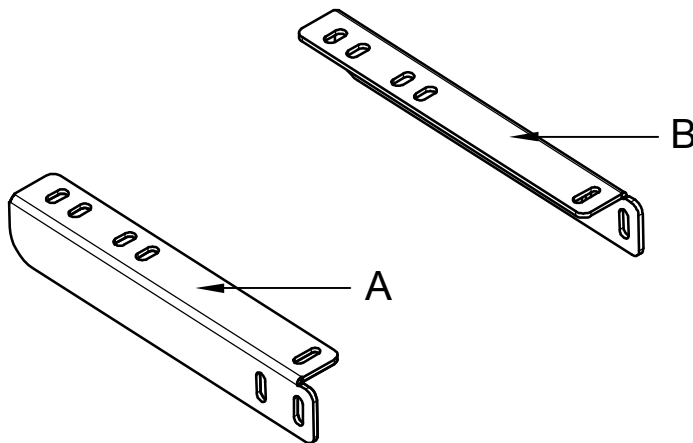

BRAKETLER / BRACKETS

A. 7535ABA L R / SOL ARKA BRAKET / LEFT REAR BRACKET

B. 7535ABA R R / SAĞ ARKA BRAKET / RIGHT REAR BRACKET

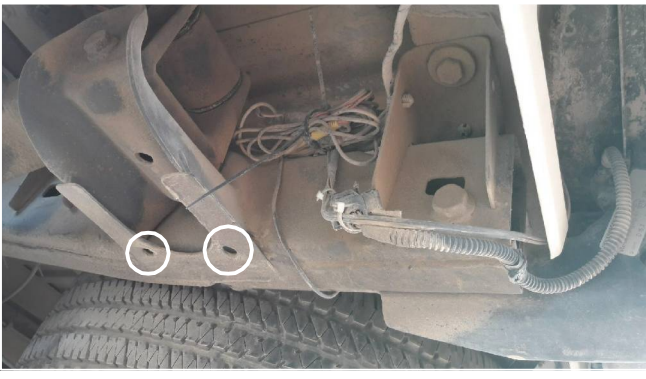

Fig. 1

LR

ARAÇ ÜZERİNDEKİ PLASTİK MUHAFAFAYI SÖKÜNÜZ
PLEASE REMOVE THE STOPPER THAT ALREADY
ATTACHED ON THE VEHICLE



Fig. 5

RR

ARAÇ ÜZERİNDEKİ PLASTİK MUHAFAFAYI SÖKÜNÜZ
PLEASE REMOVE THE STOPPER THAT ALREADY
ATTACHED ON THE VEHICLE



Fig. 2

LR

3 NUMARALI PARÇAYI YERİNE TAKINIZ
PLEASE ATTACH THE PART (PART NO 1) TO THE PLACE
SHOWN ABOVE



Fig. 6

RR

3 NUMARALI PARÇAYI YERİNE TAKINIZ
PLEASE ATTACH THE PART (PART NO 1) TO THE PLACE
SHOWN ABOVE



Fig. 3

LR

BRAKETİ CİVATALAR İLE MONTAJLAYINIZ
INSTALL THE BRACKET WITH BOLTS



Fig. 7

RR

BRAKETİ CİVATALAR İLE MONTAJLAYINIZ
INSTALL THE BRACKET WITH BOLTS



Fig. 4

LR

LEFT
REAR

BRAKETİ CİVATALAR İLE MONTAJLAYINIZ
INSTALL THE BRACKET WITH BOLTS



Fig. 8

RR

LEFT
REAR

ÜRÜNÜ MONTAJLAYINIZ
PLEASE INSTALL THE PRODUCT



MONTAJ ŞEMASI / INSTALLATION SCHEME

