

FORD RANGER 2016>

KOD / CODE : 2617DKA111

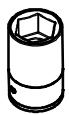

SW15 (30Nm)

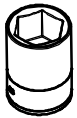

SW19 (50Nm)

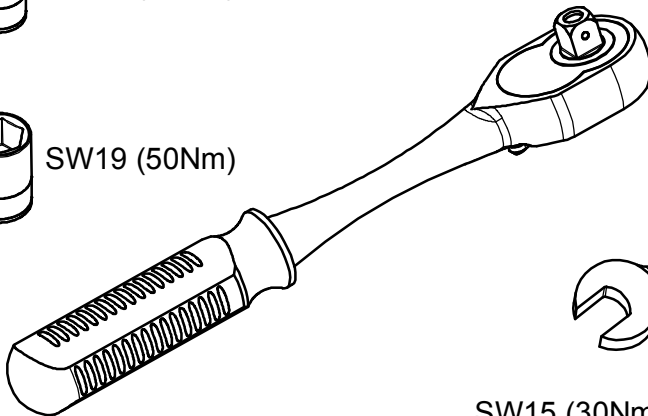

SW19 (50Nm)

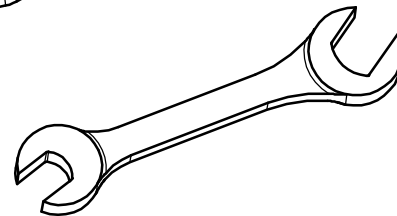

SW15 (30Nm)

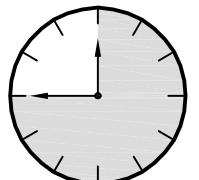

45 Min.

MONTAJ SETİ / INSTALLATION SET

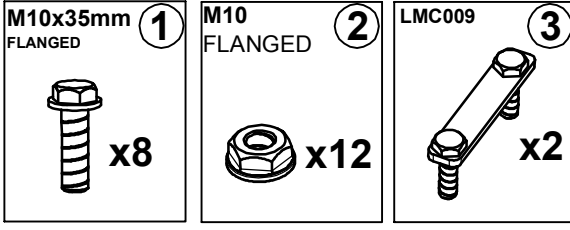

1. M10x35mm FLANŞLI CİVATA / *M10x35 BOLT FLANGED*
2. M10 FLANŞLI SOMUN / *M10 NUT FLANGED*
3. M10 LAMALI CİVATA / *M10 MOUNTING PLATE*

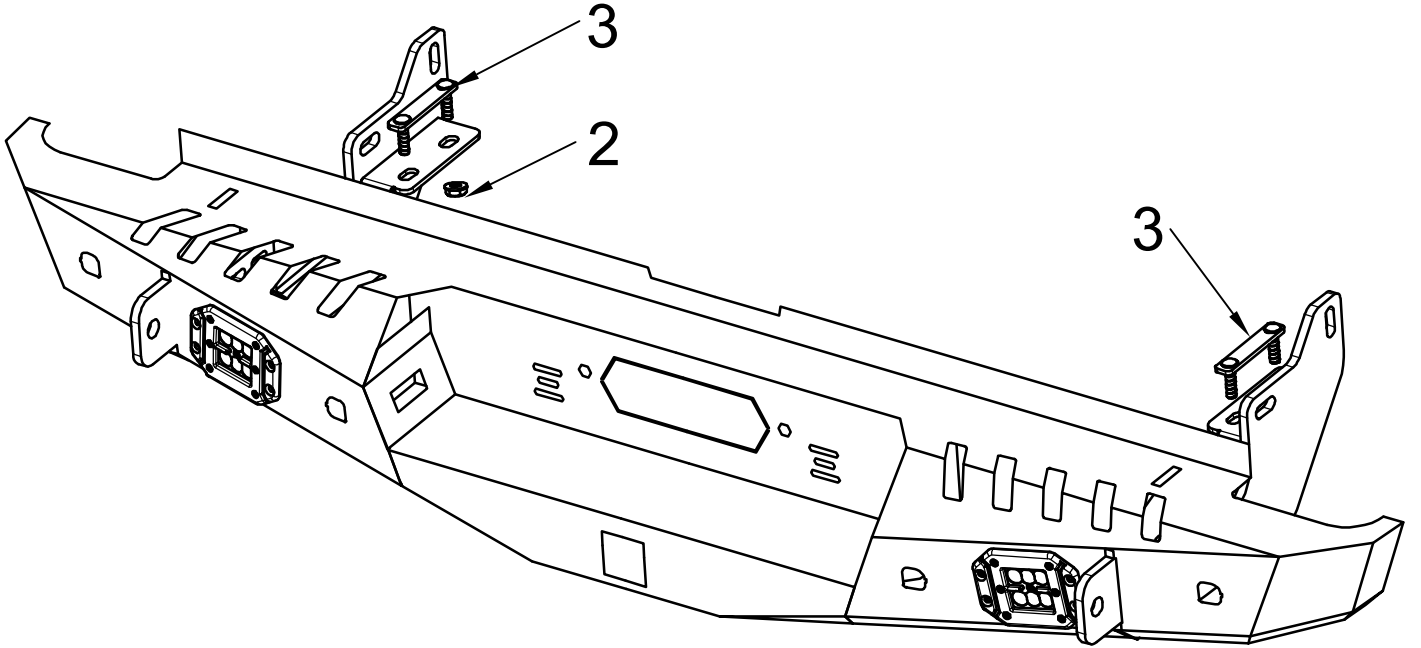

Fig. 5



3 NOLU PARÇAYI RESİMDEKİ YERİNE TAKINIZ

Fig. 6



DAKAR TAMPON BAĞLANTI BRAKETİNİ 3 NOLU PARÇA ve
ARAÇ ŞASESİNDEKİ MEVCUT YERLERİNDEN MONTAJLAYINIZ



MONTAJ ŞEMASI / INSTALLATION SCHEME

