

# VW TIGUAN 2007-2015

KOD / CODE : 7514BRK173



SW13 (20Nm)



SW17 (40Nm)

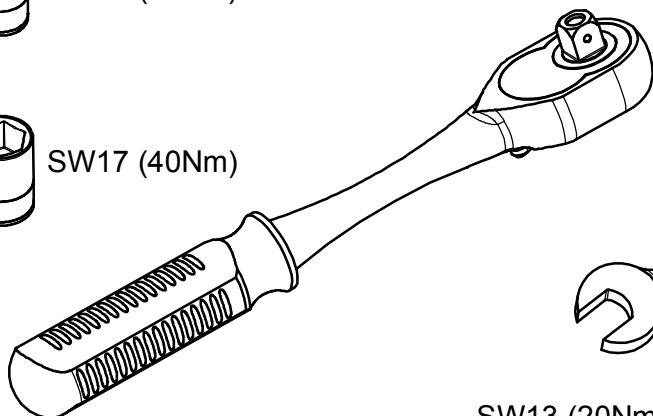

SW13 (20Nm)

SW17 (40Nm)

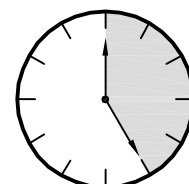
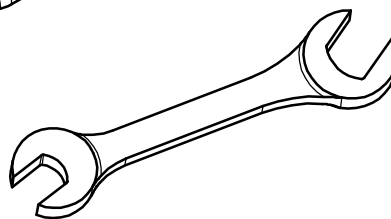

25 DAKİKA

# MONTAJ SETİ / INSTALLATION SET

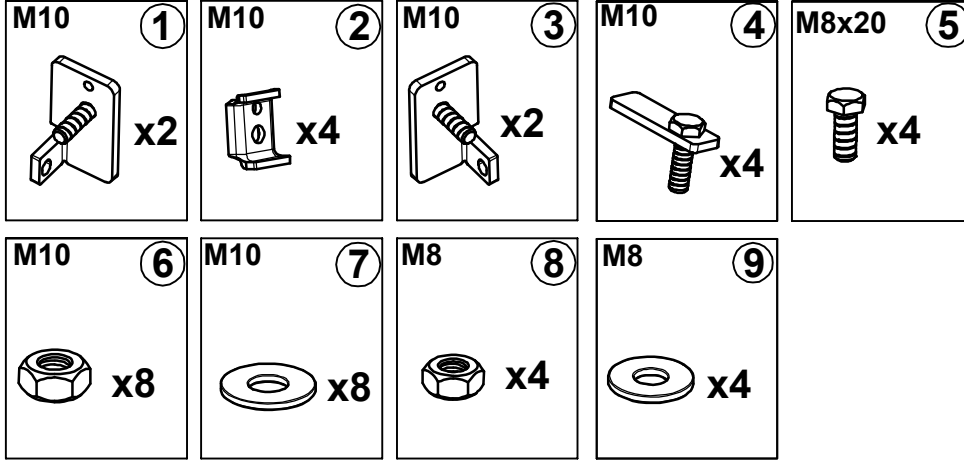

1. ETEK BAĞLANTI SAĞ / *SKIRT RING*
2. ETEK SIKMA / *SKIRTING*
3. ETEK BAĞLANTI SOL / *SKIRT RING*
4. M10 LAMALI CİVATA / *M10 MOUNTING PLATE*
5. M8x20 ANAHTAR BAŞLI CİVATA / *M8x20 KEY HEAD BOLT*
6. M10 SOMUN / *M10 NUT*
7. M10 PUL / *M10 WASHER*
8. M8 SOMUN / *M8 NUT*
9. M8 PUL / *M8 WASHER*

## **BRAKETLER / BRACKETS**

- A. 7514BRK R F / SAĞ ÖN BRAKET / *RIGHT FRONT BRACKET*
- B. 7514BRK R R / SAĞ ARKA BRAKET / *RIGHT REAR BRACKET*
- C. 7514BRK L F / SOL ÖN BRAKET / *LEFT FRONT BRACKET*
- D. 7514BRK L R / SOL ARKA BRAKET / *LEFT REAR BRACKET*

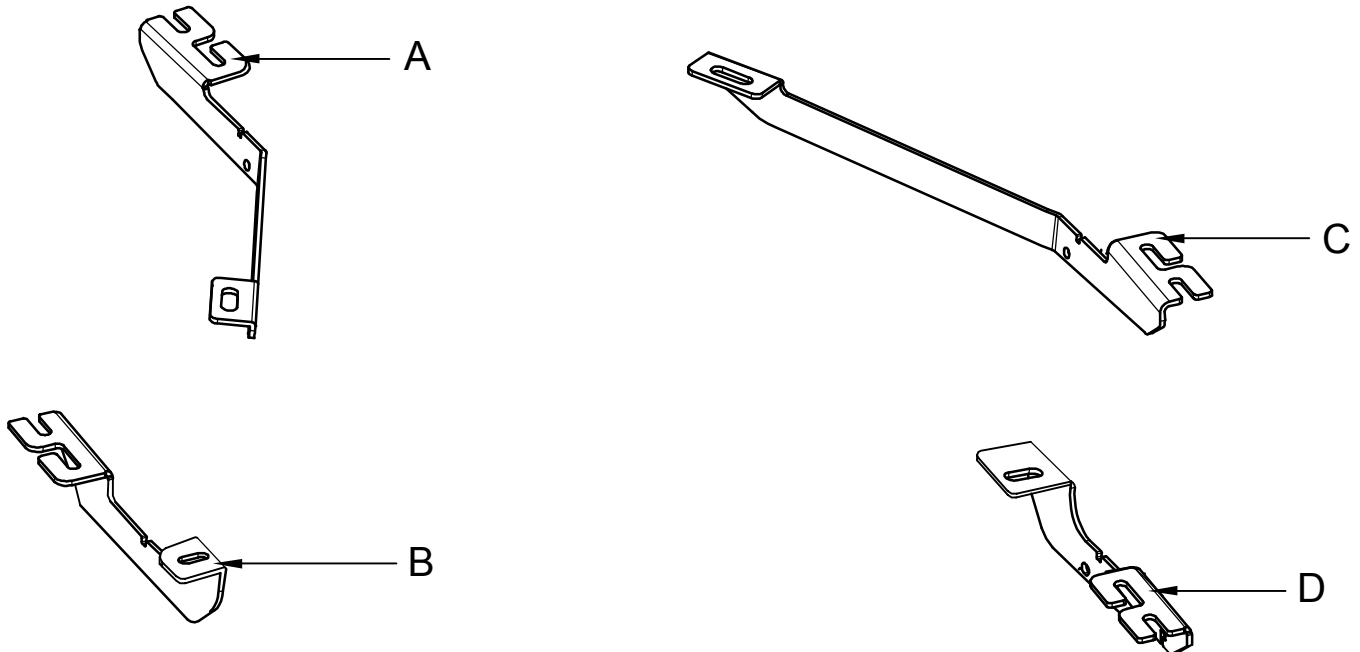
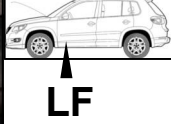



Fig. 1



LF

ARAÇ ÜZERİNDEKİ TAPAYI SÖKÜNÜZ

PLEASE REMOVE THE STOPPER THAT ALREADY ATTACHED ON THE VEHICLE

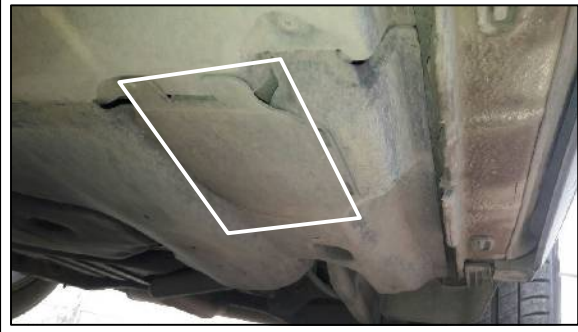
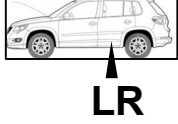

Fig. 5



LR

ARAÇ ÜZERİNDEKİ PLASTİK MUHAFAFAYI SÖKÜNÜZ

PLEASE REMOVE THE STOPPER THAT ALREADY ATTACHED ON THE VEHICLE



Fig. 2

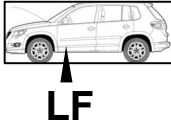

LF

4 NUMARALI PARÇAYI YERİNE TAKINIZ

PLEASE ATTACH THE PART (PART NO 4) TO THE PLACE SHOWN ABOVE



Fig. 6

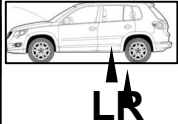

LR

ARAÇ ÜZERİNDEKİ PLASTİK MUHAFAFAYI SÖKÜNÜZ

PLEASE REMOVE THE STOPPER THAT ALREADY ATTACHED ON THE VEHICLE



Fig. 3

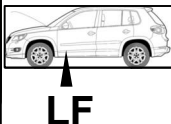

LF

BRAKETİ CIVATALAR İLE MONTAJLAYINIZ

INSTALL THE BRACKET WITH BOLTS

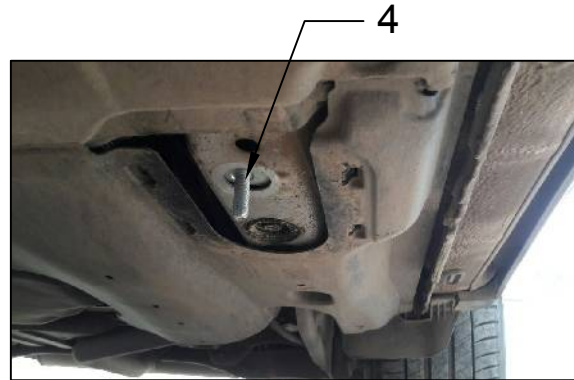
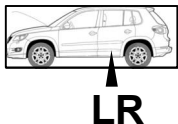

Fig. 7



LR

4 NUMARALI PARÇAYI YERİNE TAKINIZ

PLEASE ATTACH THE PART (PART NO 4) TO THE PLACE SHOWN ABOVE



Fig. 4

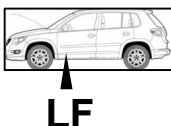

LF

BRAKETİ CIVATALAR İLE MONTAJLAYINIZ

INSTALL THE BRACKET WITH BOLTS

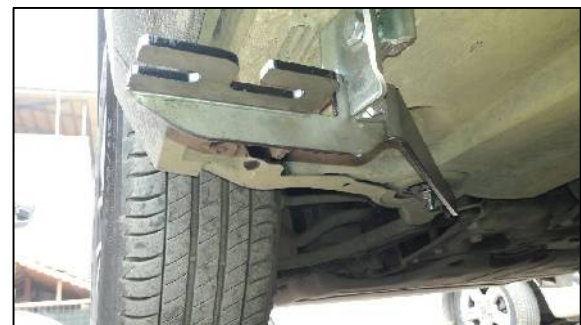
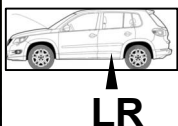

Fig. 8



LR

BRAKETİ CIVATALAR İLE MONTAJLAYINIZ

INSTALL THE BRACKET WITH BOLTS



## MONTAJ ŞEMASI / INSTALLATION SCHEME

