

SUBARU XV 2002>

KOD / CODE : 6802BRK183



SW13 (20Nm)



SW17 (40Nm)

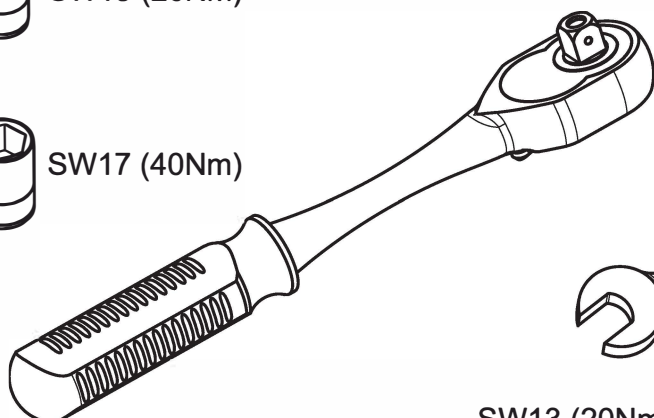

SW17 (40Nm)

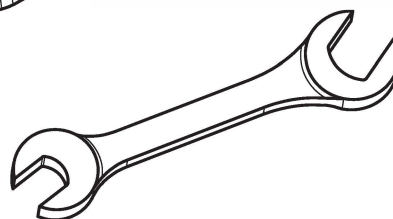

SW13 (20Nm)

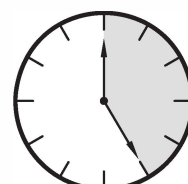

25 DAKIKA

MONTAJ SETİ / INSTALLATION SET

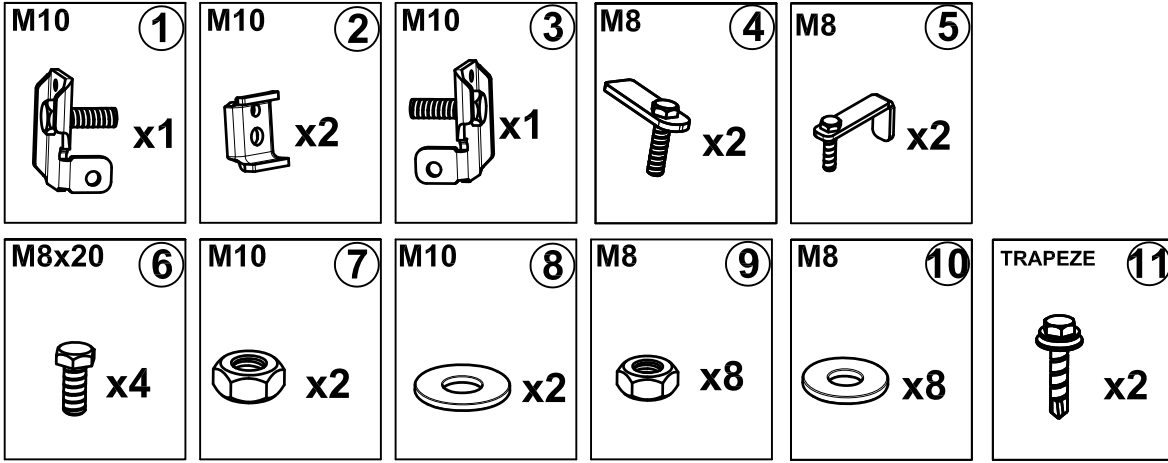

1. ETEK BAĞLANTI SAĞ / SKIRT RING
2. ETEK SIKMA / SKIRTING
3. ETEK BAĞLANTI SOL / SKIRT RING
4. M8 LAMALI CİVATA / M8 MOUNTING PLATE
5. M8 LAMALI CİVATA / M8 MOUNTING PLATE
6. M8x20 ANAHTAR BAŞLI CİVATA / M8x20 KEY HEAD BOLT
7. M10 SOMUN / M10 NUT
8. M10 PUL / M10 WASHER
9. M8 SOMUN / M8 NUT
10. M8 PUL / M8 WASHER
11. TRAPEZ VİDA / TRAPEZE SCREW

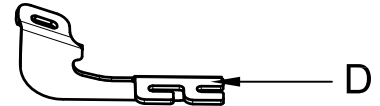
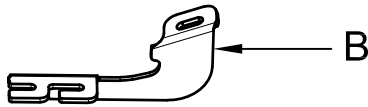
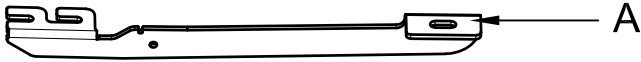

BRAKETLER / BRACKETS

- A. 6802BRK R F / SAĞ ÖN BRAKET / RIGHT FRONT BRACKET
- B. 6802BRK R R / SAĞ ARKA BRAKET / RIGHT REAR BRACKET
- C. 6802BRK L F / SOL ÖN BRAKET / LEFT FRONT BRACKET
- D. 6802BRK L R / SOL ARKA BRAKET / LEFT REAR BRACKET



Fig. 1



LF



ARAÇ ÜZERİNDEKİ PLASTİK KAPAĞI SÖKÜNÜZ

PLEASE REMOVE THE STOPPER THAT ALREADY ATTACHED ON THE VEHICLE



Fig. 5



LR

ARAÇ ÜZERİNDEKİ PLASTİK KAPAĞI SÖKÜNÜZ

PLEASE REMOVE THE STOPPER THAT ALREADY ATTACHED ON THE VEHICLE



Fig. 2



LF

5 NUMARALI PARÇAYI YERİNE TAKINIZ

PLEASE ATTACH THE PART (PART NO 5) TO THE PLACE SHOWN ABOVE



Fig. 6

4



LR

4 NUMARALI PARÇAYI YERİNE TAKINIZ

PLEASE ATTACH THE PART (PART NO 4) TO THE PLACE SHOWN ABOVE



Fig. 3



LF

BRAKETİ CİVATALAR İLE MONTAJLAYINIZ

INSTALL THE BRACKET WITH BOLTS



Fig. 7



LR

BRAKETİ CİVATALAR İLE MONTAJLAYINIZ

INSTALL THE BRACKET WITH BOLTS



Fig. 4

ÜRÜNÜ MONTAJLAYINIZ

PLEASE INSTALL THE PRODUCT



Fig. 8

ÜRÜNÜ MONTAJLAYINIZ

PLEASE INSTALL THE PRODUCT



MONTAJ ŞEMASI / INSTALLATION SCHEME

