

SPRINTER 2006-2017 CRAFTER 2006-2017

KOD / CODE : 4724BRK333

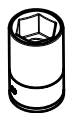

SW10 (20Nm)



SW13 (40Nm)

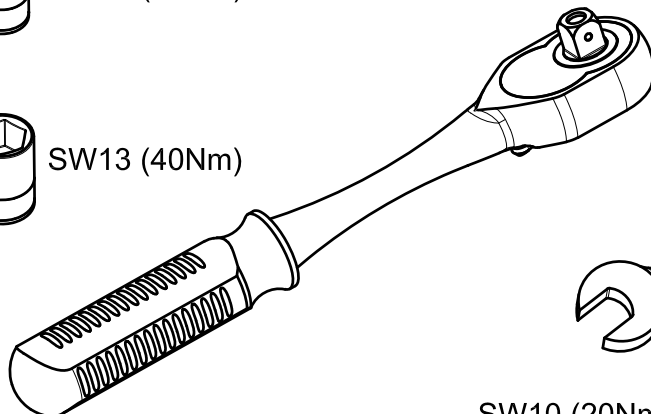

SW13 (40Nm)

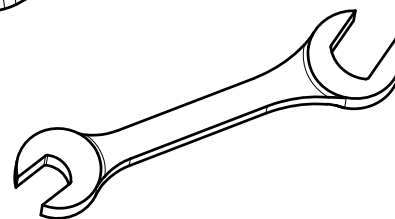

SW10 (20Nm)

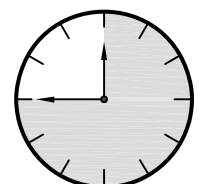

MONTAJ SETİ / INSTALLATION SET

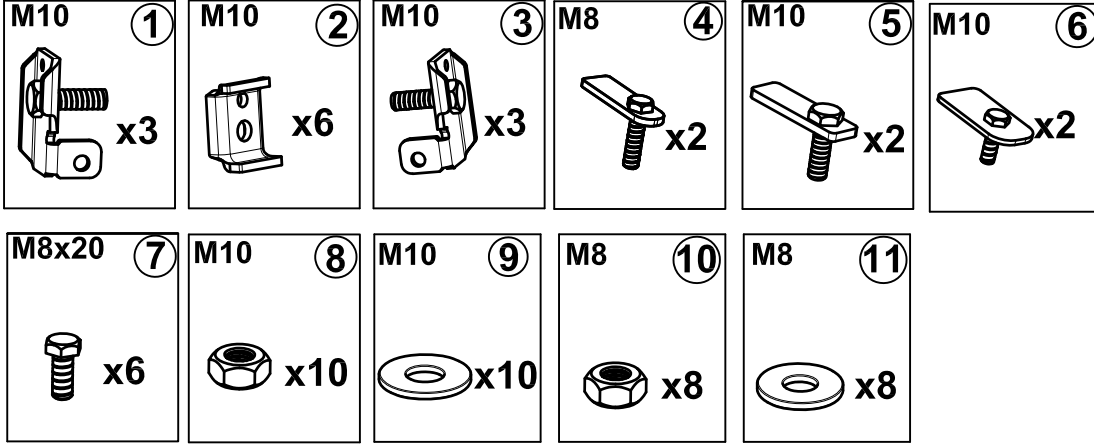

1. ETEK BAĞLANTI SAĞ / SKIRT RING
2. ETEK SIKMA / SKIRTING
3. ETEK BAĞLANTI SOL / SKIRT RING
4. M8 LAMALI CİVATA / M8 MOUNTING PLATE
5. M10 LAMALI CİVATA / M10 MOUNTING PLATE
6. M10 LAMALI CİVATA / M10 MOUNTING PLATE
7. M8x20 ANAHTAR BAŞLI CİVATA / M8x20 KEY HEAD BOLT
8. M10 SOMUN / M10 NUT
9. M10 PUL / M10 WASHER
10. M8 SOMUN / M8 NUT
11. M8 PUL / M8 WASHER

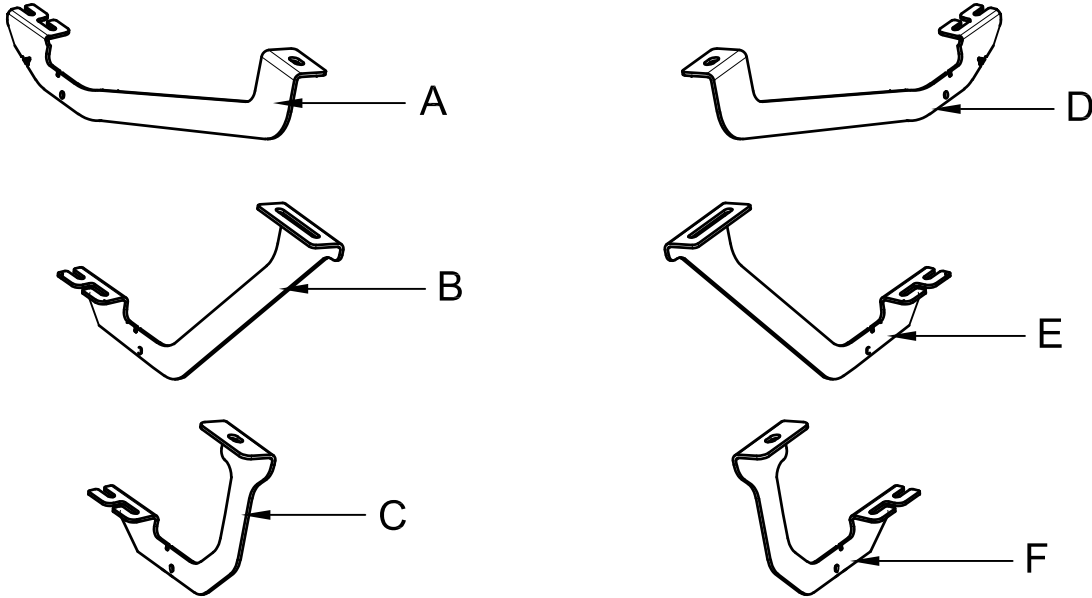

BRAKETLER / BRACKETS

- A. 4724BRK R F / SAĞ ÖN BRAKET / RIGHT FRONT BRACKET
- B. 4724BRK R M / SAĞ ORTA BRAKET / RIGHT MIDDLE BRACKET
- C. 4724BRK R R / SAĞ ARKA BRAKET / RIGHT REAR BRACKET
- D. 4724BRK L F / SOL ÖN BRAKET / LEFT FRONT BRACKET
- E. 4724BRK L M / SOL ORTA BRAKET / LEFT MIDDLE BRACKET
- F. 4724BRK L R / SOL ARKA BRAKET / LEFT REAR BRACKET



Fig. 1

LF



ARAÇ ÜZERİNDEKİ PLASTİK TAPAYI SÖKÜNÜZ

PLEASE REMOVE THE STOPPER THAT ALREADY ATTACHED ON THE VEHICLE

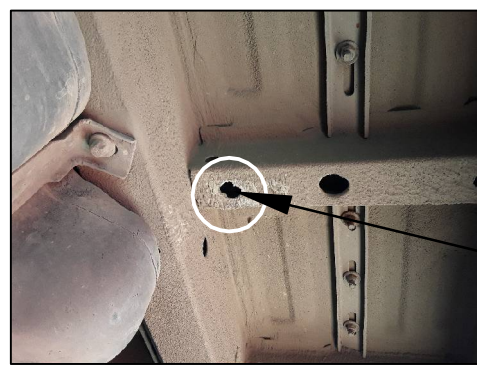

Fig. 5

LM



ARAÇ ÜZERİNDEKİ PLASTİK TAPAYI SÖKÜNÜZ

PLEASE REMOVE THE STOPPER THAT ALREADY ATTACHED ON THE VEHICLE

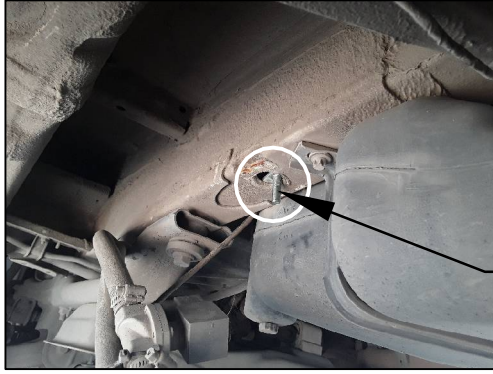

Fig. 2

LF

5

5 NUMARALI PARÇAYI YERİNE TAKINIZ

PLEASE ATTACH THE PART (PART NO 5) TO THE PLACE SHOWN ABOVE



Fig. 6

LM

4

4 NUMARALI PARÇANIN YERİNİ GÖSTERİR

PLEASE ATTACH THE PART (PART NO 4) TO THE PLACE SHOWN ABOVE



Fig. 3

LF

BRAKETİ CİVATALAR İLE MONTAJLAYINIZ

INSTALL THE BRACKET WITH BOLTS



Fig. 7

LM

BRAKETİ CİVATALAR İLE MONTAJLAYINIZ

INSTALL THE BRACKET WITH BOLTS



Fig. 4

LF

BRAKETLERİN ARAÇ ÜZERİNDEKİ YERLERİDİR

THE PLACES ARE ON THE VEHICLE



Fig. 8

BRAKETİ CİVATALAR İLE MONTAJLAYINIZ

INSTALL THE BRACKET WITH BOLTS

Fig. 9



LR



ARAÇ ÜZERİNDEKİ PLASTİK TAPAYI SÖKÜNÜZ

PLEASE REMOVE THE STOPPER
THAT ALREADY ATTACHED ON THE VEHICLE

Fig. 11



LR

BRAKETİ CİVATALAR İLE MONTAJLAYINIZ

INSTALL THE BRACKET WITH BOLTS

Fig. 10



LR

5

5 NUMARALI PARÇAYI YERİNE TAKINIZ

PLEASE ATTACH THE PART (PART NO 5)
TO THE PLACE SHOWN ABOVE

Fig. 12



ÜRÜNÜ MONTAJLAYINIZ

PLEASE INSTALL THE PRODUCT

MONTAJ ŞEMASI / INSTALLATION SCHEME

