

FORD RANGER 2006-2011 MAZDA BT-50 2006-2011

KOD / CODE : 2610BRK193

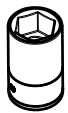

SW13 (20Nm)



SW17 (40Nm)

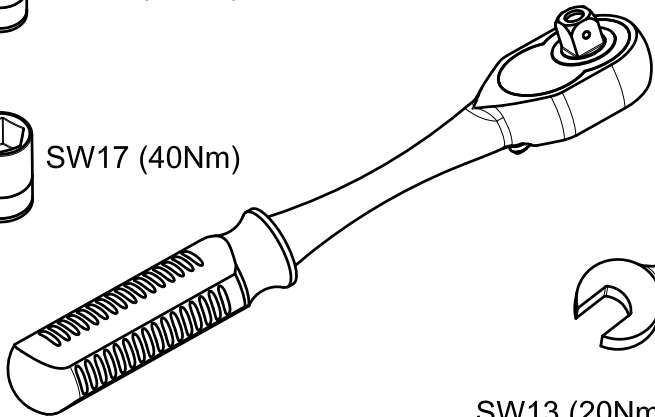

SW17 (40Nm)

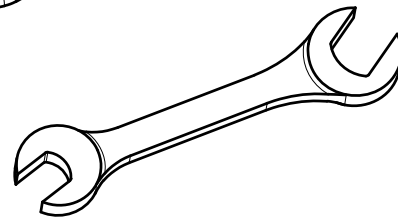

SW13 (20Nm)

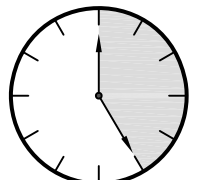

25 DAKIKA

MONTAJ SETİ / INSTALLATION SET

ARAÇ ÜZERİNDEKİ CİVATALAR İLE MONTAJLAYINIZ

INSTALL WITH THE BOLTS ON YOUR VEHICLE

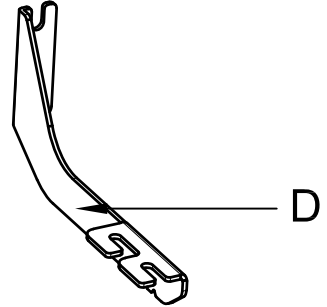
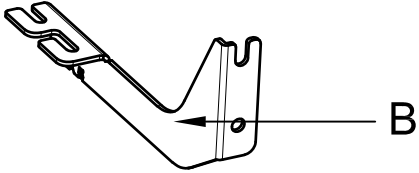
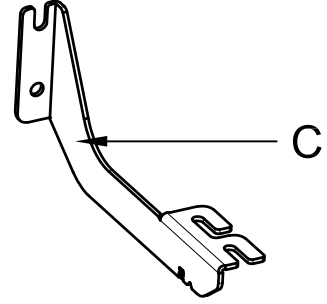
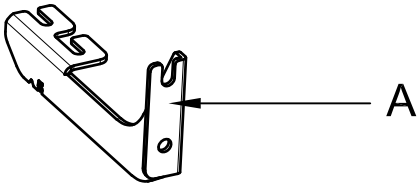

BRAKETLER / BRACKETS

A. 2610BRK R F / SAĞ ÖN BRAKET / RIGHT FRONT BRACKET

B. 2610BRK R R / SAĞ ARKA BRAKET / RIGHT REAR BRACKET

C. 2610BRK L F / SOL ÖN BRAKET / LEFT FRONT BRACKET

D. 2610BRK L R / SOL ARKA BRAKET / LEFT REAR BRACKET

Fig. 1



LF

ARAÇ ÜZERİNDEKİ CİVATALAR İLE MONTAJLAYINIZ

INSTALL WITH THE BOLTS ON YOUR VEHICLE

Fig. 4



LR

ARAÇ ÜZERİNDEKİ CİVATALAR İLE MONTAJLAYINIZ

INSTALL WITH THE BOLTS ON YOUR VEHICLE

Fig. 2



LF

ARAÇ ÜZERİNDEKİ CİVATALAR İLE MONTAJLAYINIZ

INSTALL WITH THE BOLTS ON YOUR VEHICLE

Fig. 5



LR

ARAÇ ÜZERİNDEKİ CİVATALAR İLE MONTAJLAYINIZ

INSTALL WITH THE BOLTS ON YOUR VEHICLE

Fig. 3



ÜRÜNÜ MONTAJLAYINIZ

PLEASE INSTALL THE PRODUCT

Fig. 6



ÜRÜNÜ MONTAJLAYINIZ

PLEASE INSTALL THE PRODUCT



MONTAJ ŞEMASI / INSTALLATION SCHEME

